

SPECIFICATION FOR APPROVAL

<p>CUSTOMER'S APPROVAL CHOP</p> <p>Approval's condition: _____</p> <p>Approved date: _____</p>
--

KINDLY RETURN A SET WITH YOUR COMPANY'S OFFICIAL STAMP
ON APPROVAL OF THIS ITEM

CUSTOMER'S NAME: _____

CUSTOMER'S MODEL NO. : _____

CUSTOMER'S PART NO. : _____

DESCRIPTION: **5G n78 15.9mm DR Filter**

Semitel'S MODEL NO. : **SE8R3550B500_15.9_031**

VERSION: **03**

DATE: **2025/2/19**

- Attachments:**
- Product Specification
 - Sample Qty. :
 - Test Data

Prepared By	Checked By	Approved By
Hebe Deng 2025/2/19	Liang Wong 2025/2/19	Eric Chang 2025/2/19

Semitel International Ltd.,	TEL: 886-2-86922121 FAX: 886-2-26483379
www.semitelint.com	11F., No. 43-5, Zhongxing Rd., Xizhi Dist., New Taipei City 221012, Taiwan

1.FEATURES

- Small Size, Light weight
- SMT package soldering
- Ideal for Microwave telecommunication

2.SPECIFICATIONS

ELECTRICAL SPECIFICATIONS			
NO	ITEM	SPEC	Unit
1	Center Frequency [fo]	3550	MHz
2	Bandwidth [BW]	fo ±250[3300~3800]	MHz
3	Insertion in BW	2.0 max.@25 °C	dB
		2.3max.@-40 °C to +105 °C	
4	Ripple in BW	1.5 max.	dB
5	Return Loss in BW (S11, S22)	15 min.	dB
6	In/Out Impedance	50	Ω
7	Attenuation[Absolute Value]	20 min. @ DC~3240 MHz	dB
		20 min. @ 3860~5000 MHz	dB
8	Operation Temperature Range	-40 °C to +105 °C	
9	Max Input Power	100W(C type)	
10	Measurement Semitel	MC44R	

^ All Parameters are measured with 50Ω system at +25 °C if not specified.

Semitel'S MODEL NO. :	SE8R3550B500_15.9_031	CUSTOMER'S MODEL NO. :	
VERSION:	03	CUSTOMER'S PART NO. :	
DATE:	2025/2/19		

3. OUTLINE DRAWING and Weight

3.1. Filter drawing

3.2. P/N SE8R3550B500_15.9_031 marking information as (marking showing 3550Bxxx, xxx=01~99 mean for project series code.)

3.3. Unit weight: 1.4g

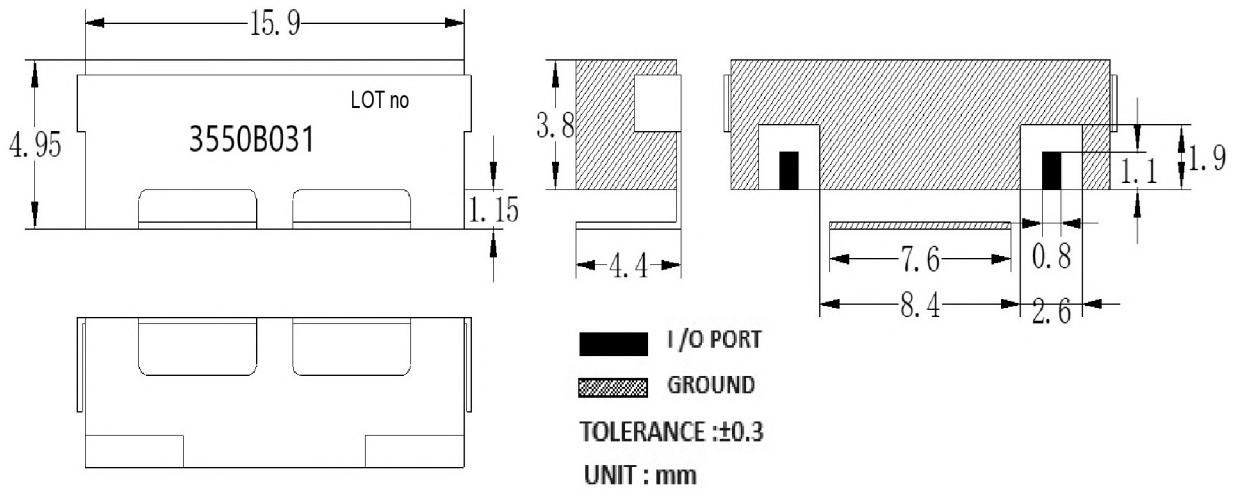

4. RECOMMENDED PC BOARD PATTERN

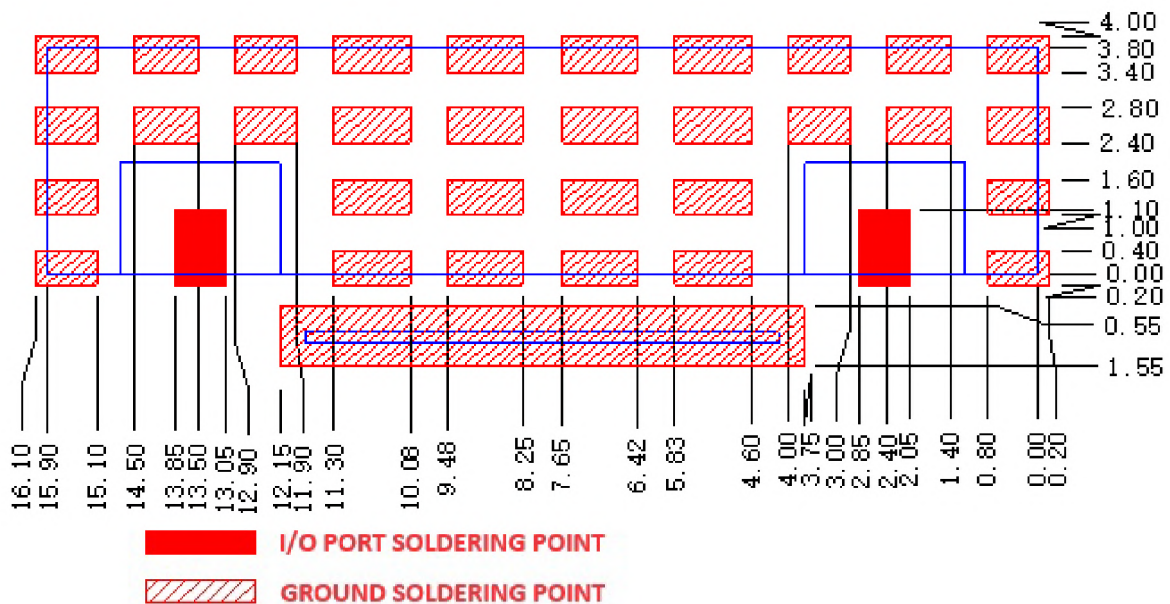

Semitel'S MODEL NO. :	SE8R3550B500_15.9_031	CUSTOMER'S MODEL NO. :	
VERSION:	03	CUSTOMER'S PART NO. :	
DATE:	2025/2/19		

5.FREQUENCY RESPONSE

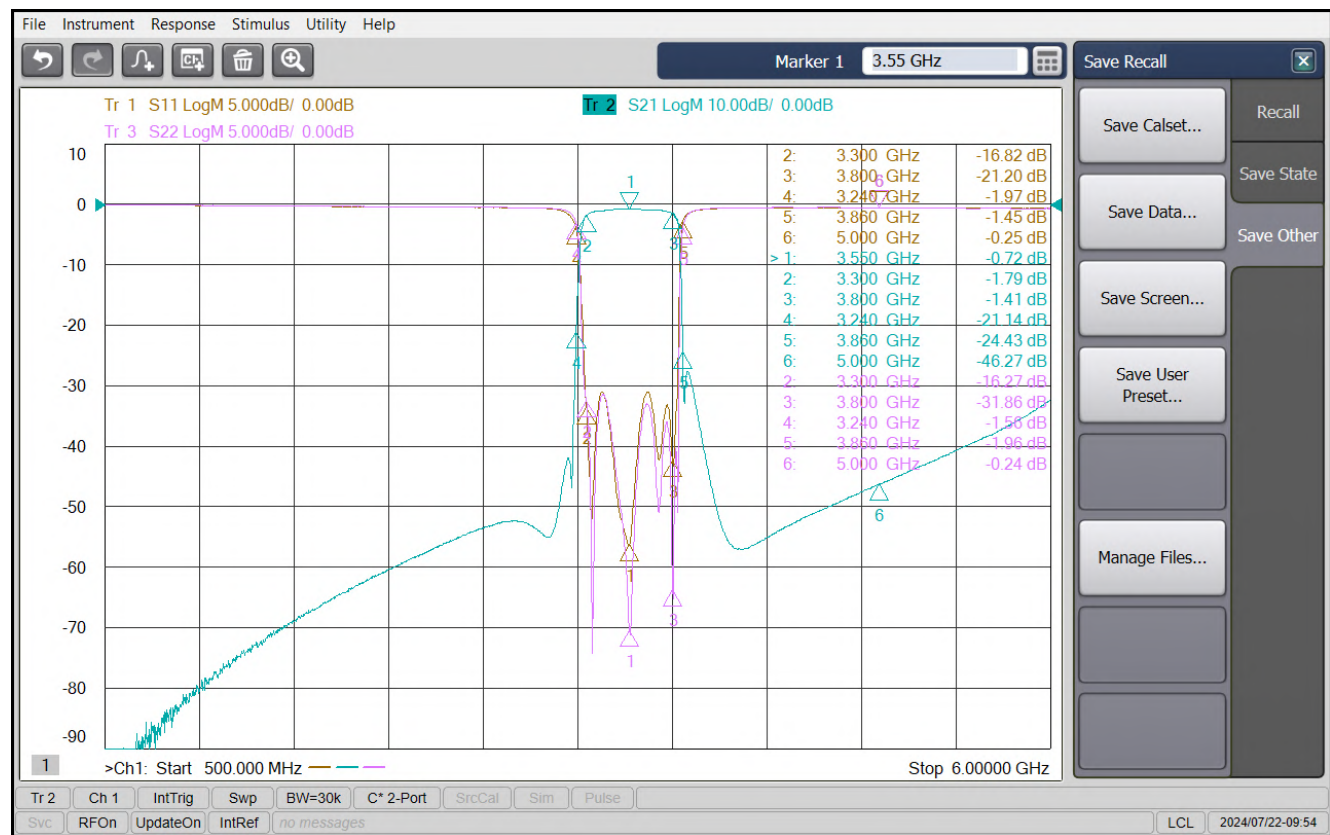
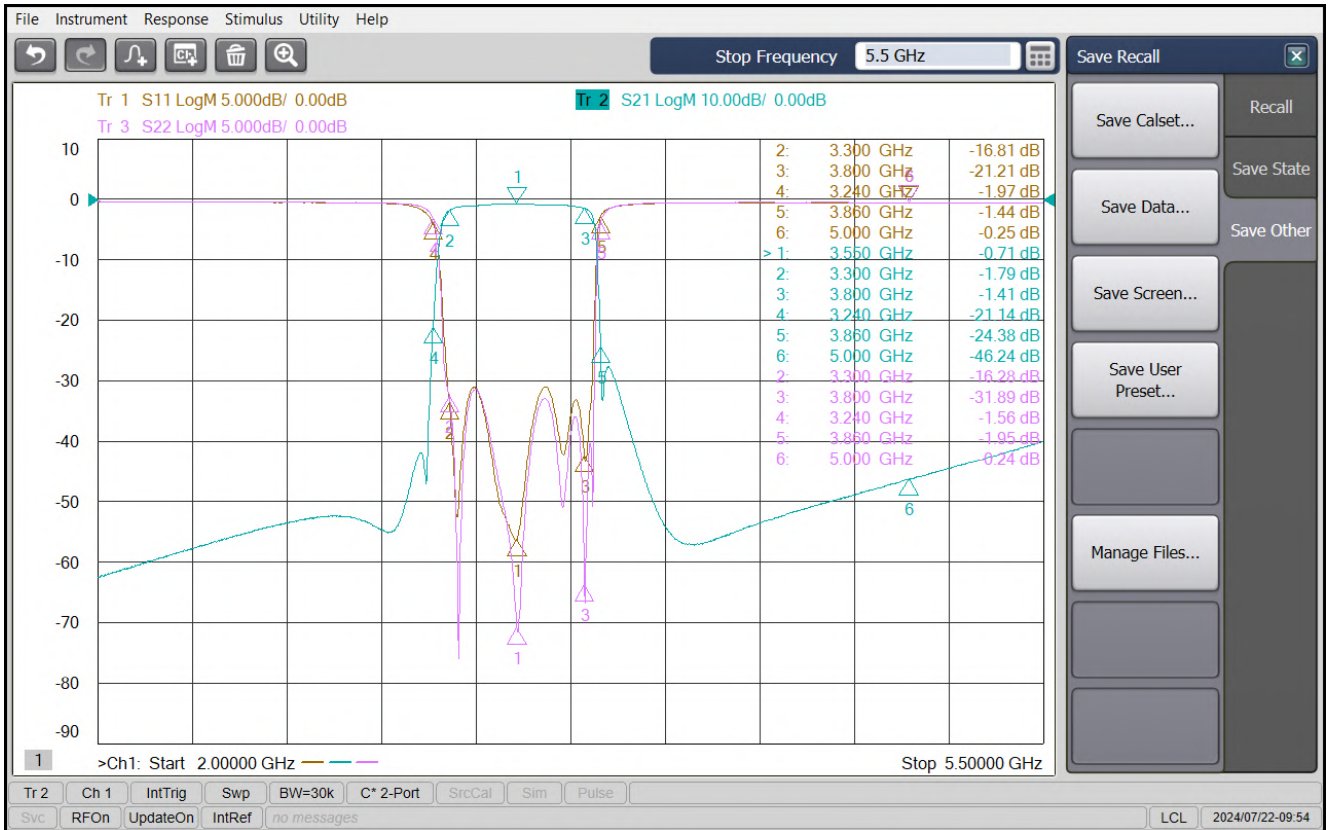

Semitel'S MODEL NO. :	SE8R3550B500_15.9_031	CUSTOMER'S MODEL NO. :	
VERSION:	03	CUSTOMER'S PART NO. :	
DATE:	2025/2/19		

6. Tape and Reel Dimension

6.1. Quantity per reel: 500 pcs

6.2. Taping Dimension

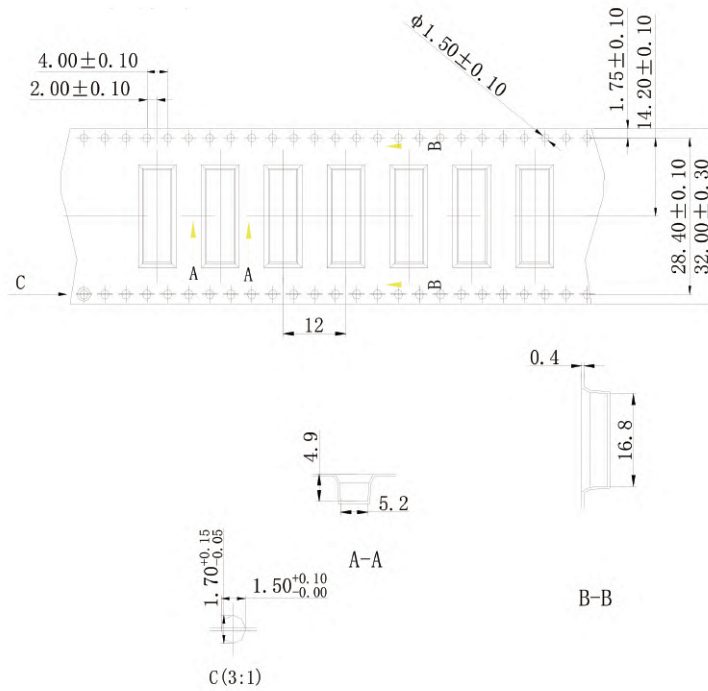

Unit : mm

6.3. Reel Dimension

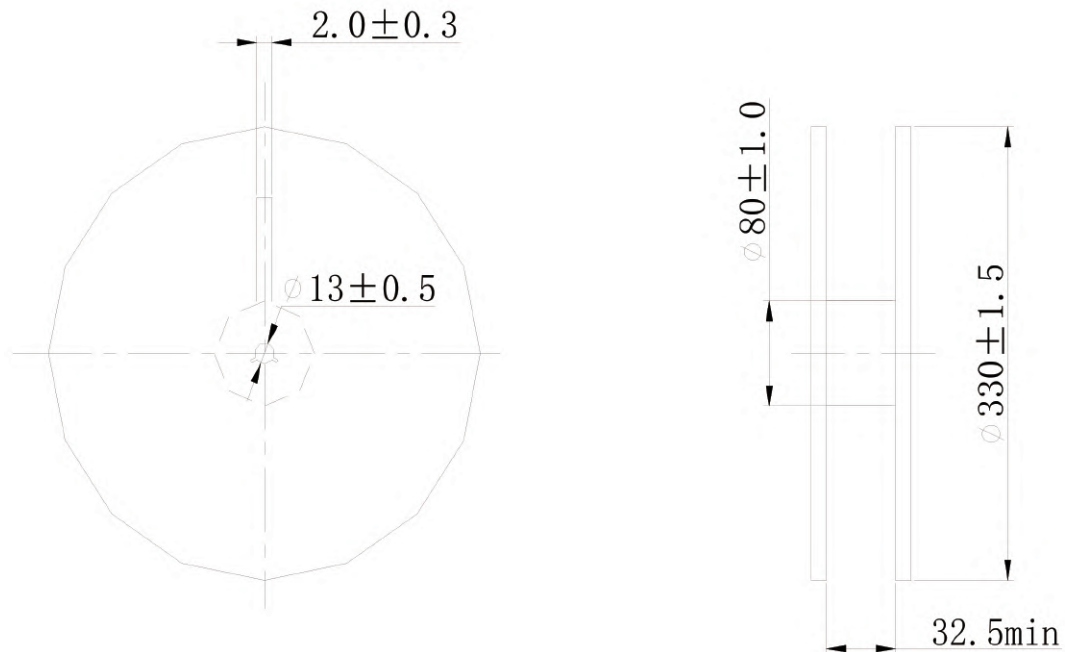

Semitel'S MODEL NO. :	SE8R3550B500_15.9_031	CUSTOMER'S MODEL NO. :	
VERSION:	03	CUSTOMER'S PART NO. :	
DATE:	2025/2/19		

7.Environmental Test

7.1 Vibration Resist

The device should satisfy the electrical characteristics after applied to the vibration of 10 to 55Hz with amplitude of 1.5mm for 2 hours each in X, Y and Z directions.

7.2 Steady Damp Heat Test

The device should satisfy the electrical characteristics after exposed to the temperature $40 \pm 2^{\circ}\text{C}$ and the relative humidity 90~95% RH for 96 hours and 1~2 hours recovery time under normal condition.

7.3 High Temperature Storage

The device should satisfy the electrical characteristics after exposed to temperature $85 \pm 5^{\circ}\text{C}$ for 96 \pm 2 hours and 1~2 hours recovery time under normal temperature.

7.4 Low Temperature Storage

The device should also satisfy the electrical characteristics after exposed to the temperature $40^{\circ}\text{C} \pm 5^{\circ}\text{C}$ for 96 \pm 2 hours and to 2 hours recovery time under normal temperature.

7.5 Thermal Shock

The device should also satisfy the electrical characteristics after exposed to the low temperature -40°C and high temperature $+85^{\circ}\text{C}$ for 30 \pm 2 min each by 5 cycles and 1 to 2 hours recovery time under normal temperature.

Semitel'S MODEL NO. :	SE8R3550B500_15.9_031	CUSTOMER'S MODEL NO. :	
VERSION:	03	CUSTOMER'S PART NO. :	
DATE:	2025/2/19		

8. Notice

1. RoHS 2.0
2. MSL-2a
3. Reflow temperature recommendation

Profile feature		Pb-Free Assembly(SnAgCu)
PREHEAT	Temperature Min(Tsmin)	150°C
	Temperature Max(Tsmax)	200°C
	Time(ts) (from Tsmin to Tsmax)	60-120 seconds
RAMP-UP	Ramp-up rate (TL to TP)	3 °C/second max.
REFLOW	Liquidus Temperature(TL)	217°C
	Total Time maintained above TL (t L)	30-100 seconds
PEAK	Temperature(TP)	250°C
	Time (tp)	25 seconds
RAMP-DOWN	Ramp-down rate (TP to TL)	6 °C / second max.
Time (from 25°C to Peak Temperature) 25°C		8 minutes max.

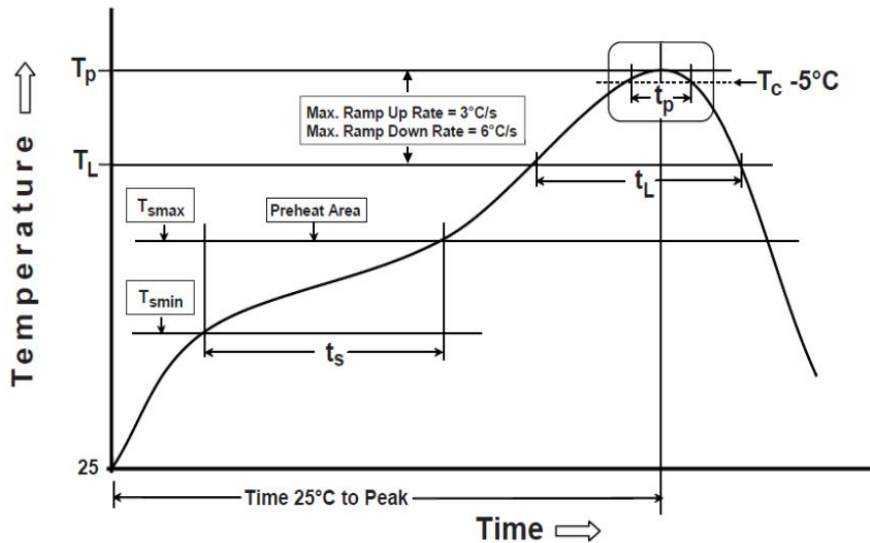

This product may not be used in the following environments:

1. Ambient air containing corrosive gas and volatile or combustible gas.
2. In liquid and in environments with a high concentration of airborne particles.

Semitel'S MODEL NO. :	SE8R3550B500_15.9_031	CUSTOMER'S MODEL NO. :	
VERSION:	03	CUSTOMER'S PART NO. :	
DATE:	2025/2/19		